

RESCAPELITE

INSTRUCTIONS

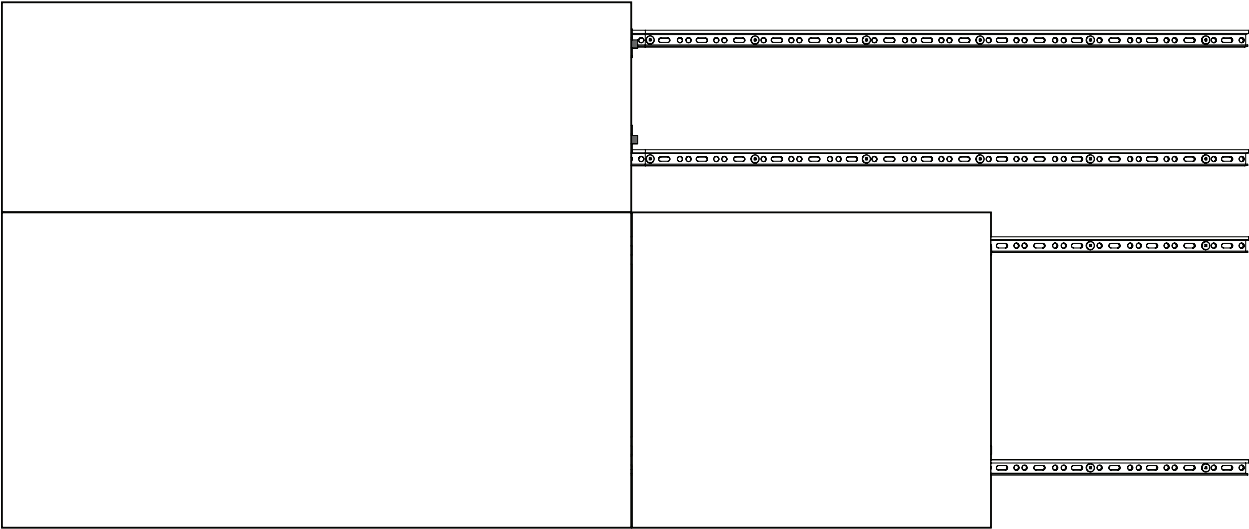

three h

INCLUDED HARDWARE

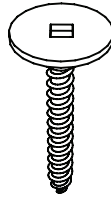

FastCap Screw

REQUIRED TOOLS

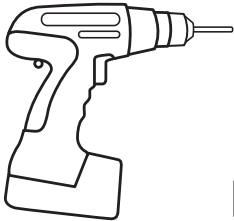

Electric Drill



Level



Ruler/ Tape
Measurer



Chalk Line

GETTING STARTED

Prior to assembly, mark your wall studs and ensure desking is level.

The FastCap Screws provided are for Wood Constructed studs only.

The installer will provide fasteners for any other stud material.

Hardware & tools required may vary depending on the Rescape™ Lite specifics.
The following instructions do not specify the amount of hardware included.
Due to variations in design, a separate hardware list will be provided.

DISCLAIMERS!

- Product that is damaged by the end user due to misuse, accident, abuse, negligence or shipping is not covered under Three H warranty.
- Use tools and hardware mentioned above to avoid any product faults.
- It is best to assemble our furniture with 2 or more persons.
- If you believe you are missing pieces, please contact replacements@three-h.com



STEP 1

Measure

- A. Measure the total height of the tile from the surface upwards and make a mark.
- B. From the top mark, measure down 3" and snap a chalk line here.
- C. From the bottom mark, measure up 3" and snap a chalk line.

Rescape Lite tiles include 3" inset brackets that clip into the Rails.

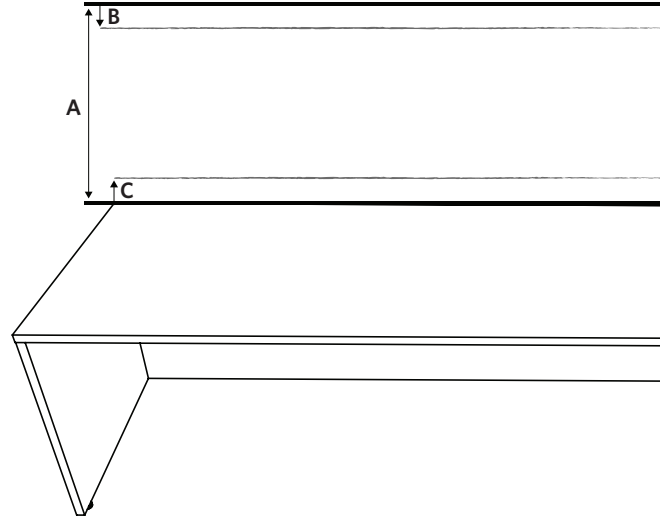

STEP 2

Install the Rails

Centered on the chalk line, begin fastening the rail on the pre-marked stud locations.

Mount using FastCap Screws.

A min. of 4 Screws per rail is recommended.

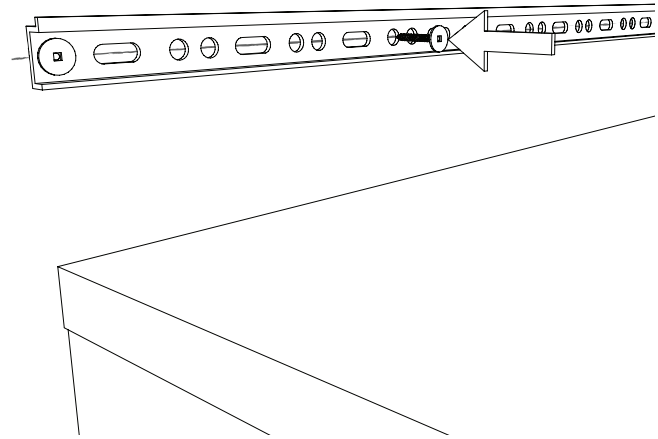
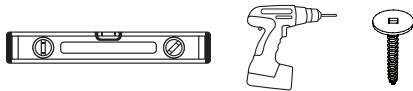

STEP 3

Install the Tiles

Carefully hang the tiles on the rails.

Starting with the tile slightly above the rails, slide it downwards to clip the brackets onto the rail (Figure A).

Lift upwards slightly to slide left or right for tile alignment.

Repeat Steps 1 to 3 for all tiles.

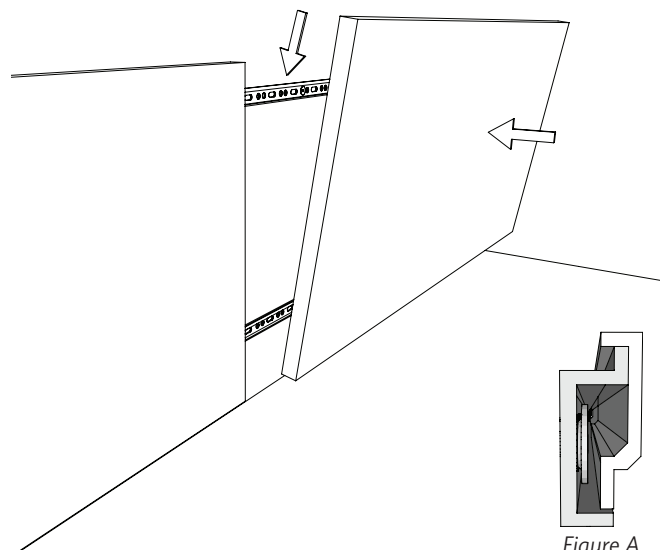

Figure A

Need Help?

customer.service@three-h.com | 1.800.767.5374

three h